

COLORING FUN! JUST THINK OF HAPPY THOUGHTS!

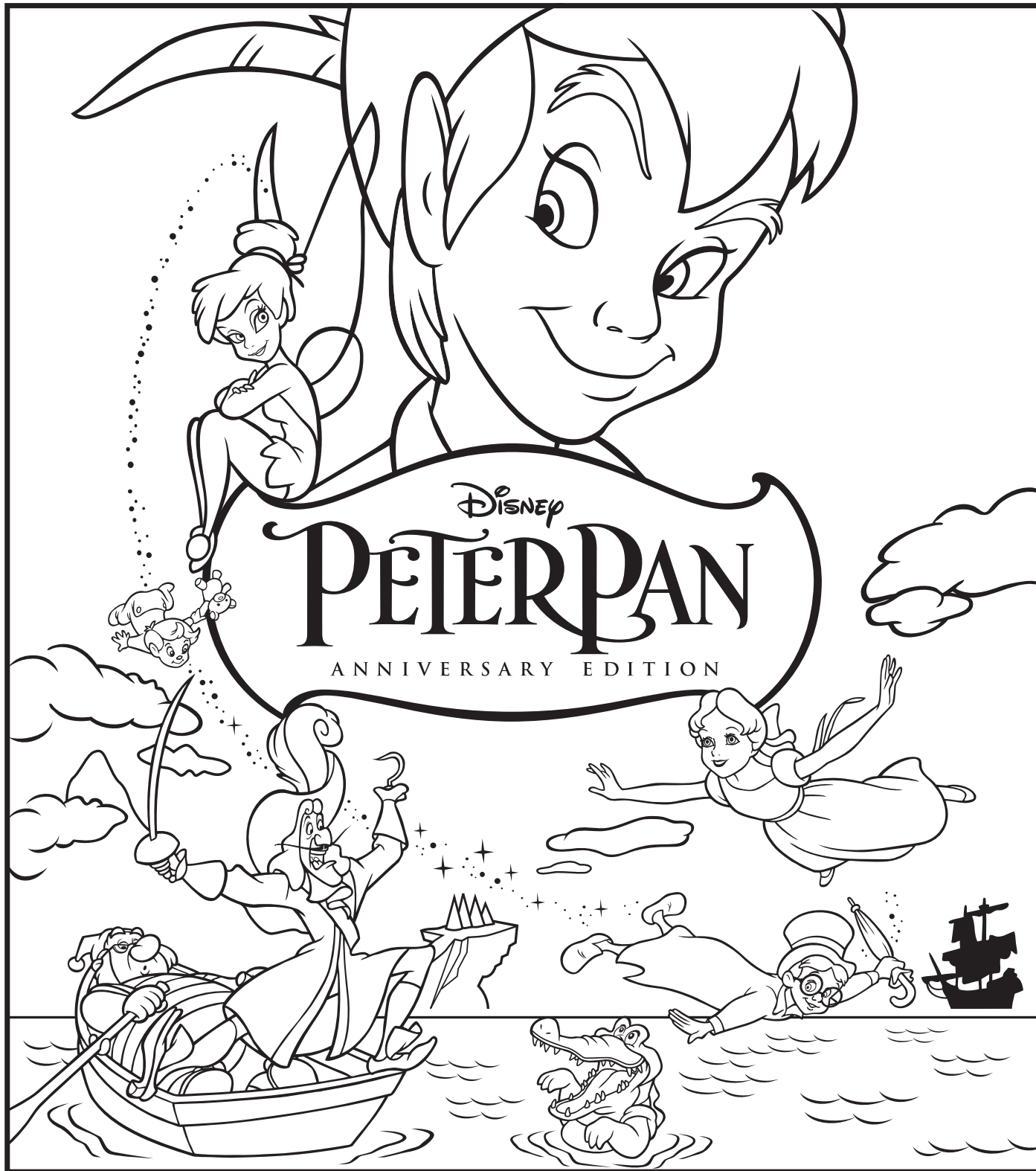

© 2018 Disney

Disney
PETER PAN
ANNIVERSARY EDITION

NOW AVAILABLE ON DIGITAL

RE-CREATE THE MAGIC IN YOUR OWN HOME!**Featuring character cutouts of Peter, Tink, Captain Hook, Wendy, Tick Tock****WHAT YOU'LL NEED**

- Large cardboard box in the size you'd like
- Scissors or a box cutter (ask an adult to complete this portion)
- Wax paper or white cloth (a handkerchief or a piece of an old sheet)
- Flashlight
- Tape
- Several pencils or popsicle sticks
- Crayons, markers or construction paper for decoration

BUILD YOUR SHADOW THEATRE

- 1: Find an empty cardboard box.
- 2: Draw a line within the box frame, leaving a 2 inch border (fig. 1).
- 3: Ask an adult to cut along this line to create your screen.
- 4: Cut along the bend to remove the top, bottom & opposite side of box, leaving the two sides to fold out as wings (fig. 2).
- 5: Ask an adult to cut a piece of wax paper or white cloth (a handkerchief or a piece of an old sheet) big enough to cover the opening in the frame. Use masking tape to attach this tightly to the back side of the screen (fig. 3).
- 6: Position your screen on a table edge and set up an unshaded light behind the screen (fig. 5).
- 7: Ask an adult to cut out the provided shadow puppet shapes. Attach a popsicle stick or pencil (with tape) to the back of the cutout for the puppeteer to hold and move the character.

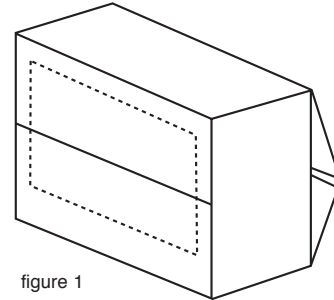

figure 1

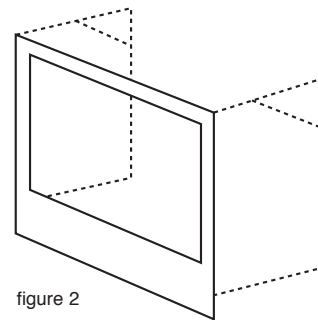

figure 2

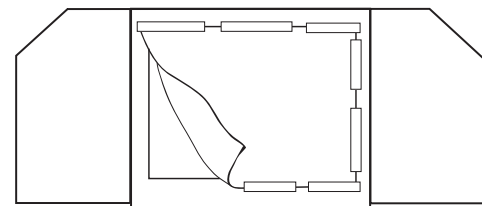

figure 3 (rear construction)

PRESENT YOUR SHADOW SHOW:

Drape a tablecloth over the table front to hide your activity from the audience.

Place an unshaded lamp or flashlight on a chair behind the puppeteer area as shown.

Puppeteers sit or kneel on the floor behind the screen to operate your puppets.

Hold your puppets between the light and the screen, and the audience will see the shadows that you create on the other side.

If possible, turn out other unnecessary room lights to help the audience focus on the puppets' actions on screen.

Create additional scenery – trees, mountains, the pirate ship, Big Ben, etc., to tell your stories.

Stage your own adventure with any combination of these characters.

- Help Wendy find Peter's Shadow
- Peter rescues Tink from Captain Hook
- Tick Tock nearly catches Captain Hook

<see next page for your shadowbox character cutouts>

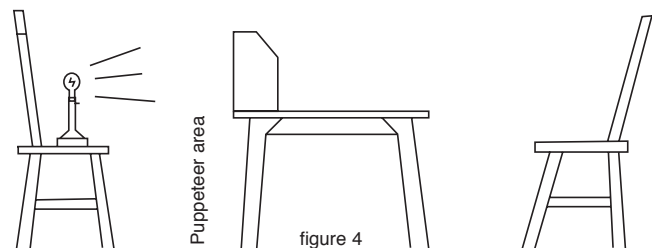
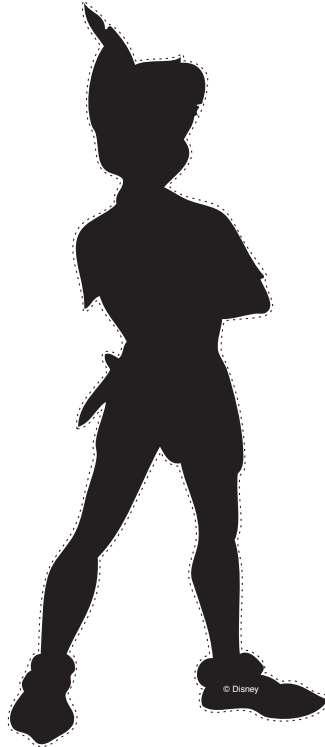
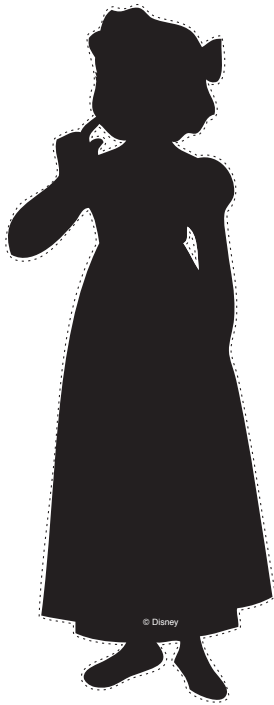

figure 4



**NEVER LAND SHADOWBOX
THEATRE**

“ARGH” YOU READY TO PLAY SUDOKU?



SWASHBUCKLING FUN WITH PETER PAN!

1				
2				
3				
4				

Test your logic with this puzzle game. Cut out and place the icons below from the *Peter Pan* movie in the empty squares so that each icon appears only once in each row and column.



ANSWERS: Row 1: Tinker Bell - Cap, Row 2: Hook - Ship - Hook, Row 3: Hook - Ship - Hook - Ship - Hook - Cap, Row 4: Cap - Tinker Bell - Hook - Ship.

© 2018 Disney

Disney
PETER PAN
ANNIVERSARY EDITION

NOW AVAILABLE ON DIGITAL

Follow Peter Pan To Never Land!

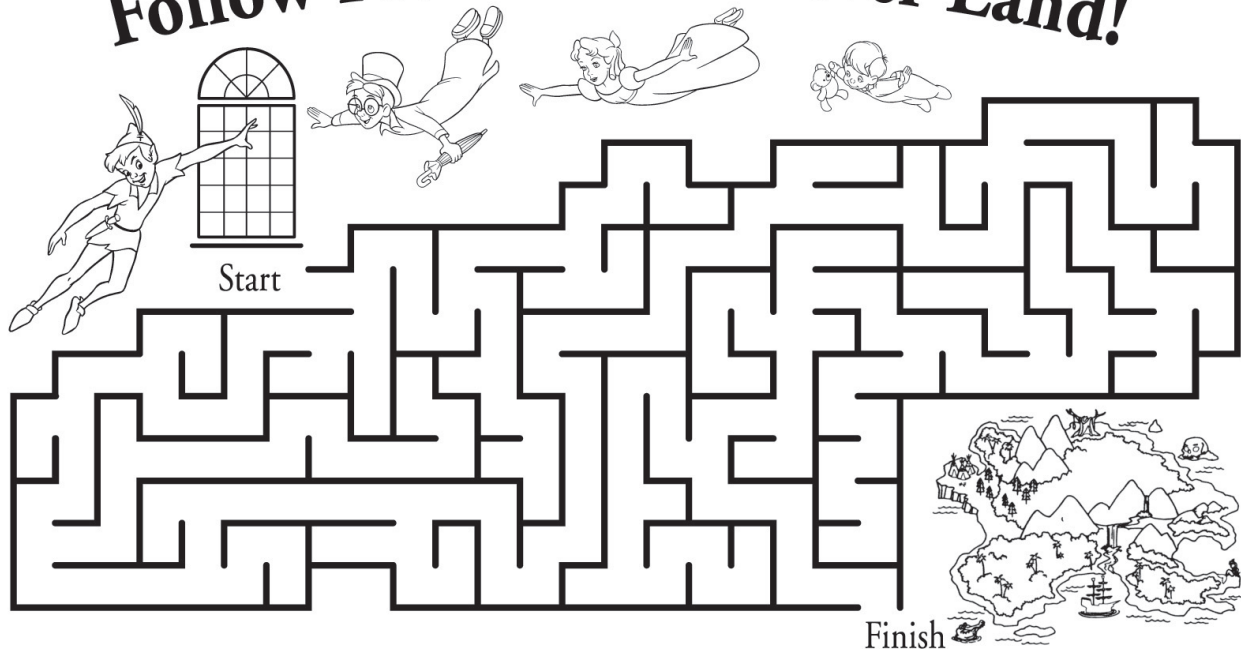

What Belongs To Whom?

Draw a line between the character and the right object and then color everything in!



Answers: Peter Pan and Shadow, Captain Hook and Ship, Crocodile and "Ticking" Clock.

Somebody's Been Tinkering With Tinker Bell!

Color the two who are exactly alike!

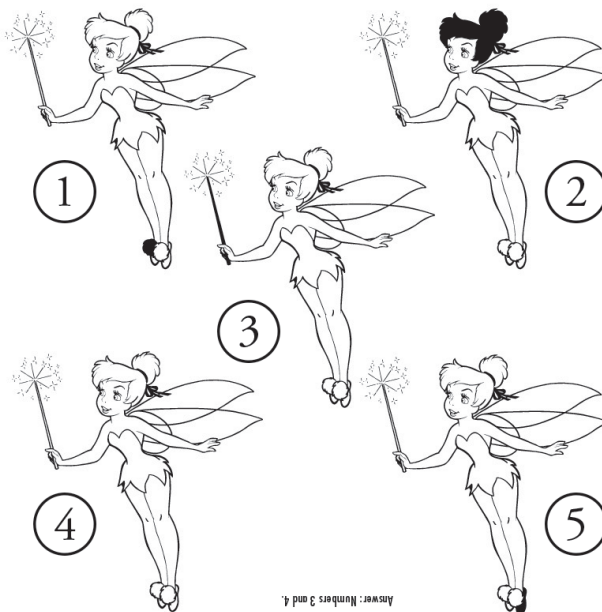

Answer: Numbers 3 and 4.

© 2018 Disney

DO YOU BELIEVE IN FAIRIES? COLOR TINKER BELL.

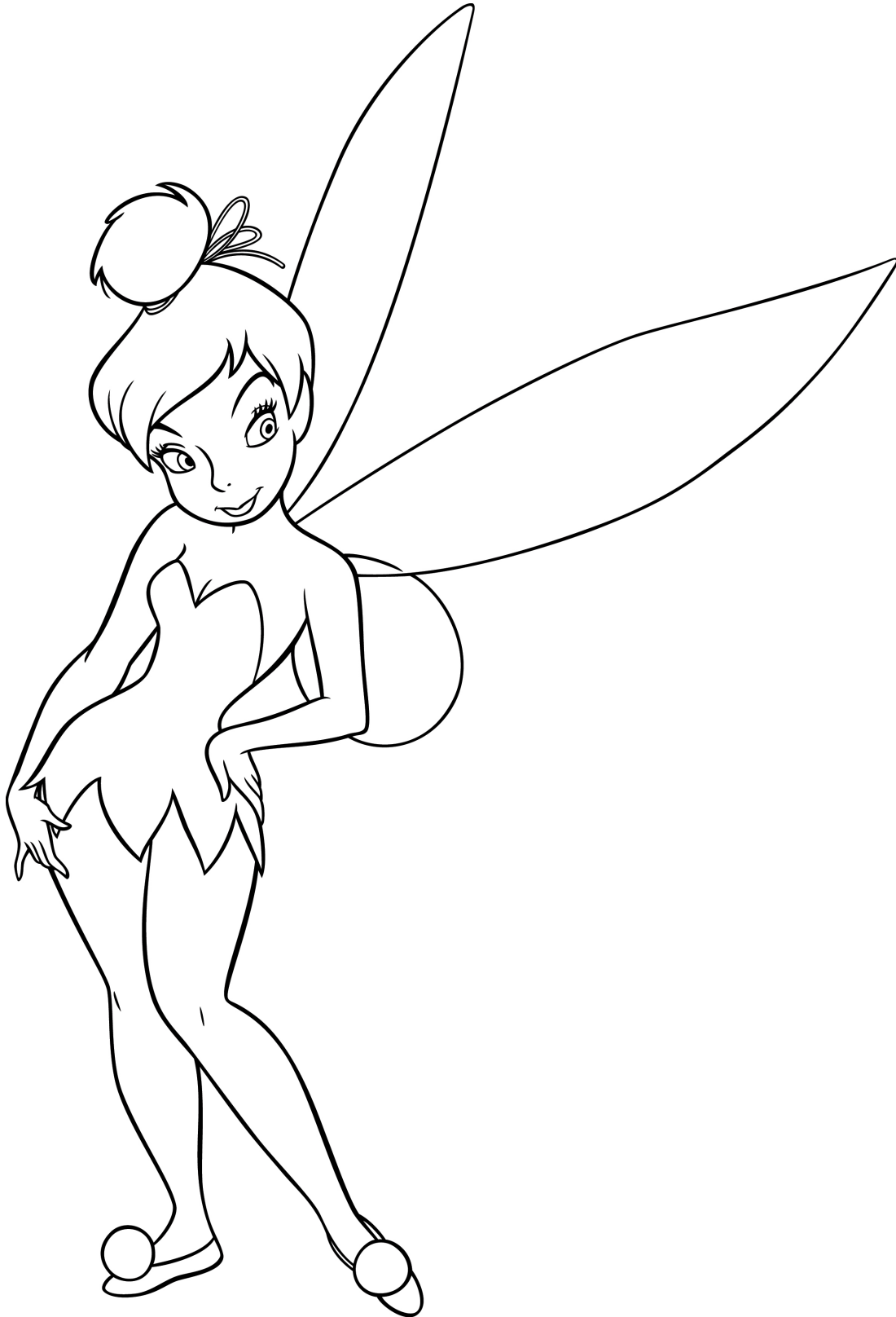

© 2018 Disney

Disney
PETER PAN
ANNIVERSARY EDITION

NOW AVAILABLE ON DIGITAL

ACTIVITY FUN!

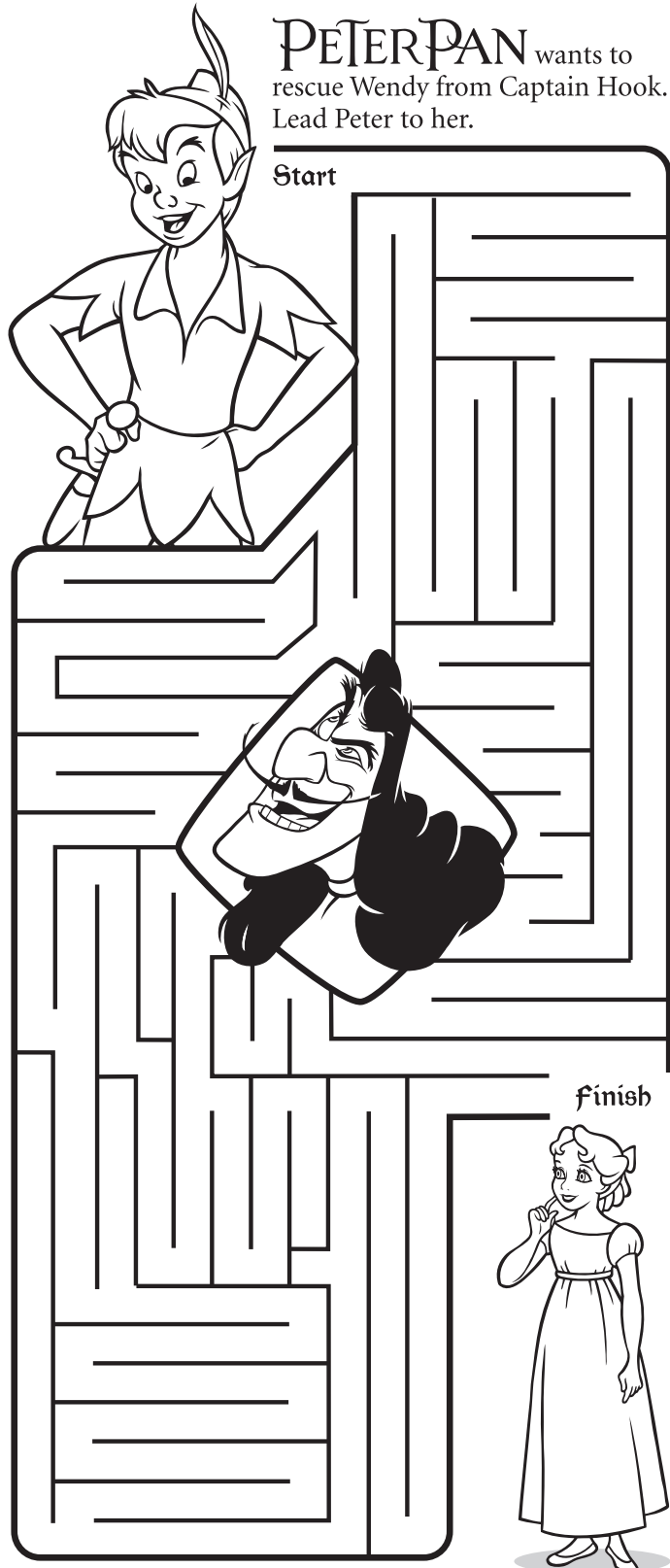

Little Michael likes to play games, but he could use your help with this one. Find and circle the hidden words.

- | | |
|---------------------|-------------------|
| Captain Hook | John |
| Wendy | Never Land |
| Smee | Michael |
| Peter Pan | Lost Boys |

R	K	E	U	G	K	F	J	G	O	L	T	K	S
R	N	E	V	E	R	L	A	N	D	K	R	N	E
L	A	M	E	S	G	J	H	U	H	D	H	G	A
E	G	S	E	U	R	P	F	O	K	O	S	R	W
A	S	G	A	I	S	H	J	L	J	L	T	K	E
H	A	R	Y	I	M	P	E	T	E	R	P	A	N
C	B	B	G	N	E	N	T	F	C	H	G	E	D
I	A	N	F	L	O	S	T	B	O	Y	S	T	Y
M	H	P	K	L	F	G	A	K	F	N	R	R	G
P	H	J	C	A	P	T	A	I	N	H	O	O	K



LET'S MAKE SNACKS WITH TINKER BELL AND CAPTAIN HOOK!

PETER PAN SNACKS



Join us in celebrating the Digital release of *PETER PAN* by creating these deliciously healthy snacks, inspired by your favorite pixie, Tinker Bell, and the crafty Captain Hook.



TINKER BELL'S Perfectly Pixie Nectar

INGREDIENTS:

1/2 cantaloupe – peeled, seeded and cubed
1 lime, juiced
2 tablespoons honey

PREPARATION:

With the help of an adult, in a blender, combine cantaloupe, lime juice and honey. Blend until smooth. Pour into glasses and serve.

Makes 2 magical servings



CAPTAIN HOOK'S Honey Oat Planks



INGREDIENTS:

2 cups pitted dates, chopped
1 cup water
1/2 cup honey
1 teaspoon vanilla
2 eggs
2 cups rolled oats
1 1/2 cups unbleached flour
1/2 cup butter
1/2 tsp. baking soda

PREPARATION:

With the help of an adult, cream honey and butter together. Add 2 eggs, vanilla and water; mix thoroughly. Add flour, baking soda, dates and rolled oats. Pour into 9x9 - inch buttered baking pan. Bake at 350 degrees for 25 to 30 minutes.

Cool and cut into 12 planks.



© 2018 Disney

Disney
PETER PAN
ANNIVERSARY EDITION

NOW AVAILABLE ON DIGITAL

COLOR IN THE NEVER LAND HERO, PETER PAN!



© 2018 Disney

Disney
PETER PAN
ANNIVERSARY EDITION

NOW AVAILABLE ON DIGITAL

COLOR THE WORLD'S MOST FAMOUS CROOK, CAPTAIN HOOK!



© 2018 Disney

Disney
PETER PAN
ANNIVERSARY EDITION

NOW AVAILABLE ON DIGITAL



STAR LOCATOR Have an adult help you with this activity!

How do you get to Never Land? Second star to the right and straight on till morning. Build your own star locator and find the brightest star!

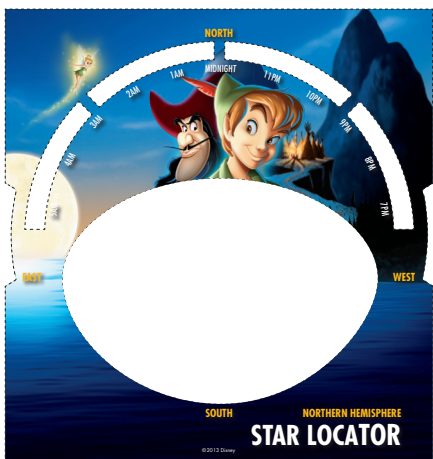

You will need » Printer, Card Stock Paper, Scissors, Brass Brad, Glue Stick

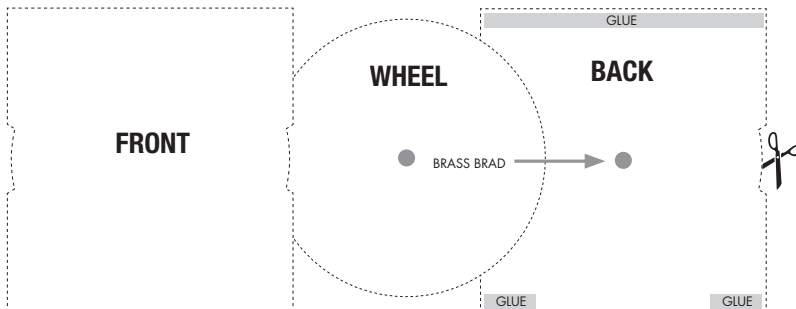

Print » Print the star locator and star wheel according to the hemisphere that you live in (Northern or Southern).

Cut » Stack the front and back pages of the star locator together, so the printed sides are exposed, then have an adult help you cut along the dashed lines that are located on the front side of the star locator, making sure you cut through both pieces of paper. Cut the star wheel separately and put aside.

Assemble » Glue the front and back of the star locator together along the top. Let dry.

Fold the front of the star locator up without creasing and place the star wheel between the two sides. Secure in the center with a brass brad. Apply glue to the open corners of the back side of the star locator. Fold the front of the star locator down, making sure the edges do not touch the star wheel so it can rotate, but securing the wheel between the front and back. Let dry.

If you live above the equator, print this page out. This is the front side of your star locator.

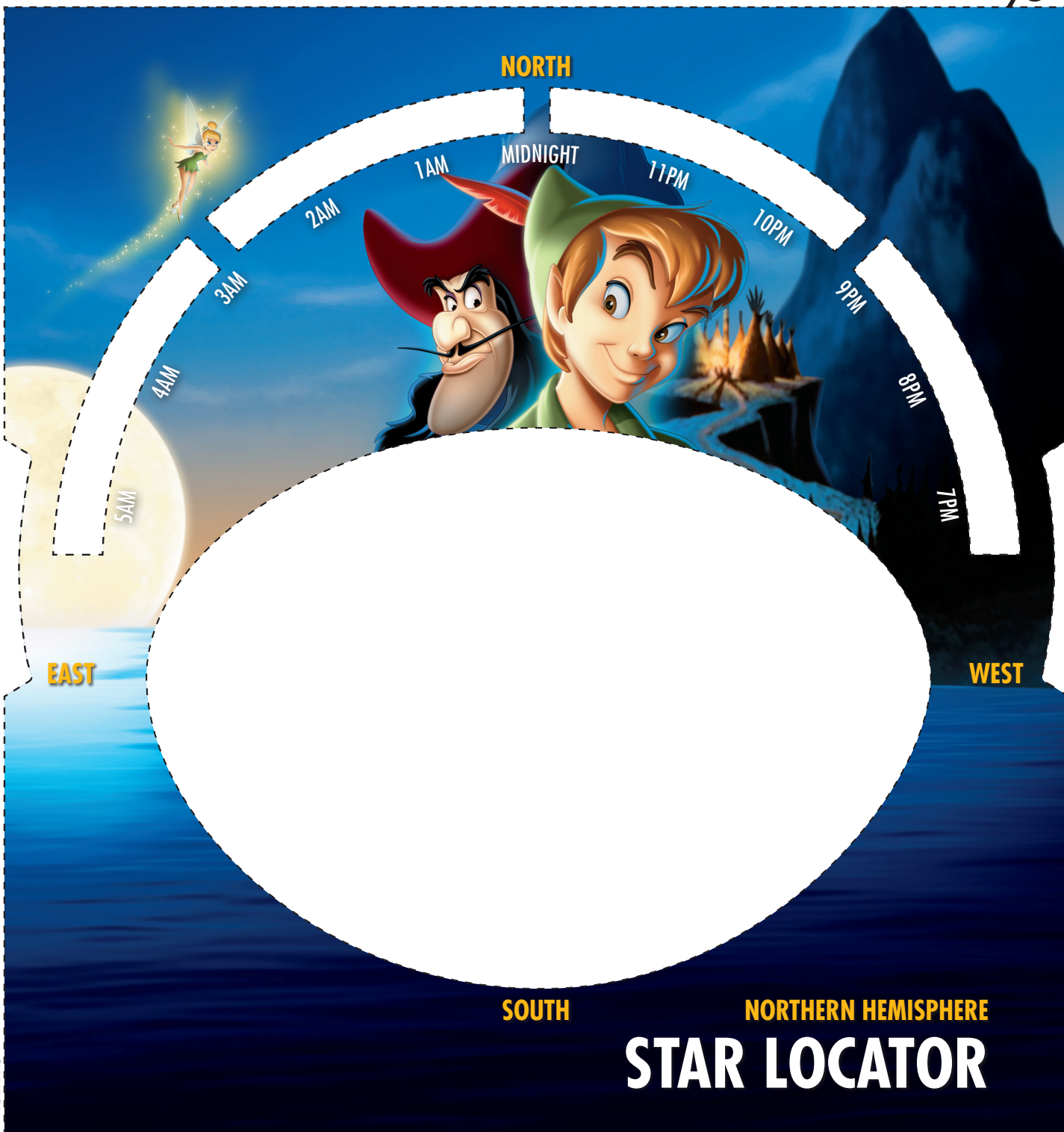

© 2018 Disney



NOW AVAILABLE ON DIGITAL

If you live above the equator, print this page out. This is the back side of your star locator.



STAR LOCATOR

Outer space is filled with trillions of stars and planets! For thousands of years, long before the invention of the telescope, humans observed and studied the twinkling lights that fill our night skies. Early star gazers would locate and identify stars by grouping and connecting them in shapes called constellations. Constellations are basically dot-to-dot pictures made from the stars above. These pictures were created and used by farmers, poets and astronomers to tell stories, mark the seasons and map the heavens. Now you can find these constellations yourself using your own STAR LOCATOR!

Because of Earth's rotation the locations of stars and constellations are always moving. By adjusting the time and date settings on your STAR LOCATOR, you can see a map of the constellations that are visible from where you are.

Please note: This chart reads Standard Time, please set the chart back an hour to adjust for Daylight Savings Time.

- 1) Rotate the star wheel so that the TIME lines up with the current DATE.
- 2) Use a compass or ask a grown-up to help you find NORTH.
- 3) Hold the STAR LOCATOR above your head and look up at it.
- 4) Rotate the whole STAR LOCATOR so that NORTH is pointing north and SOUTH is pointing south.
- 5) The stars will appear in the same relative positions on the STAR LOCATOR as they do in the sky.

If you'd like to see the stars and planets close up, visit the worldwide telescope online at nasa.gov and see images from all over the universe!

If you live above the equator, print this page out. This is the star wheel.

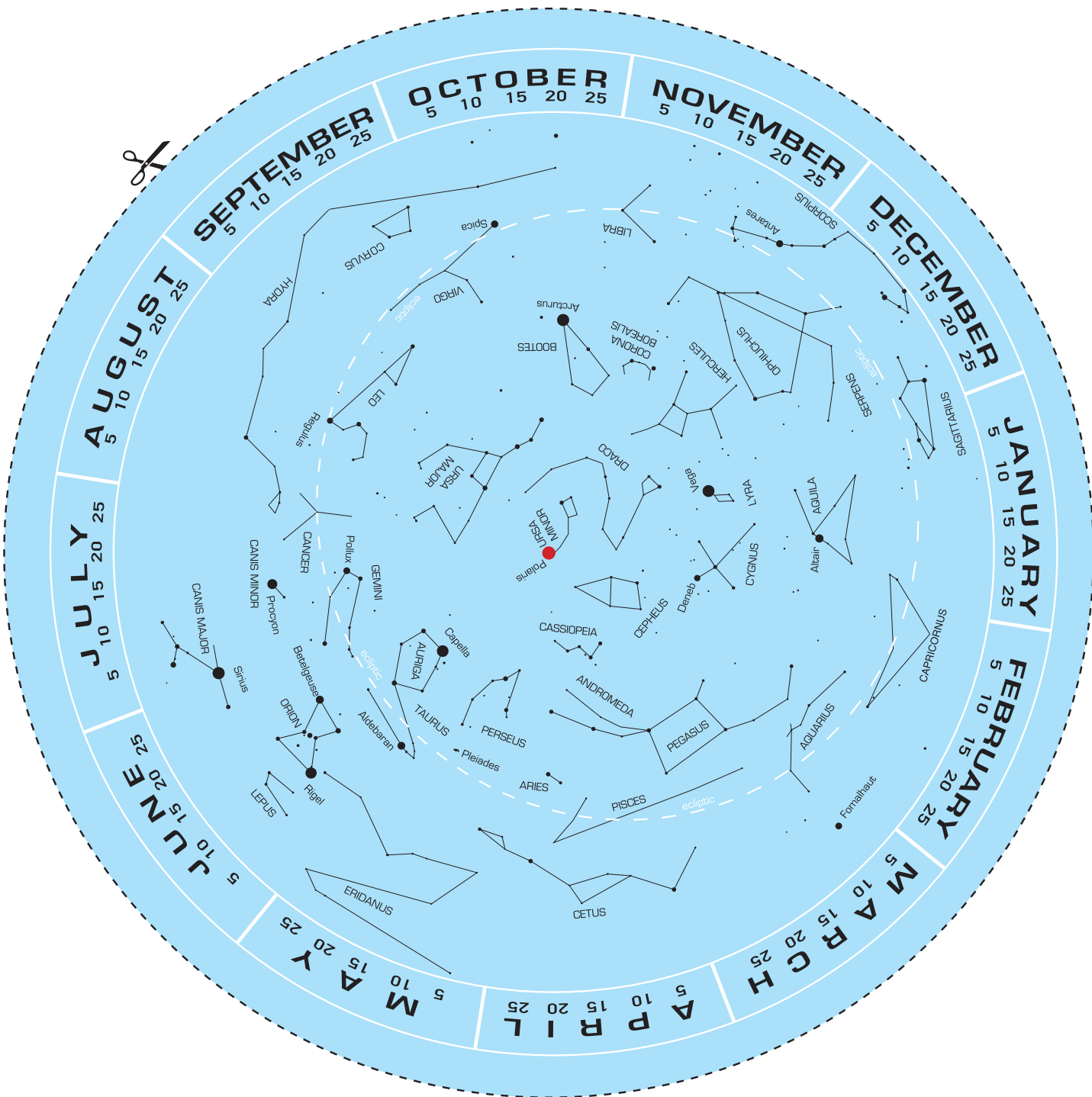

© 2018 Disney

If you live below the equator, print this page out. This is the front side of your star locator.
Have an adult help you with this craft.

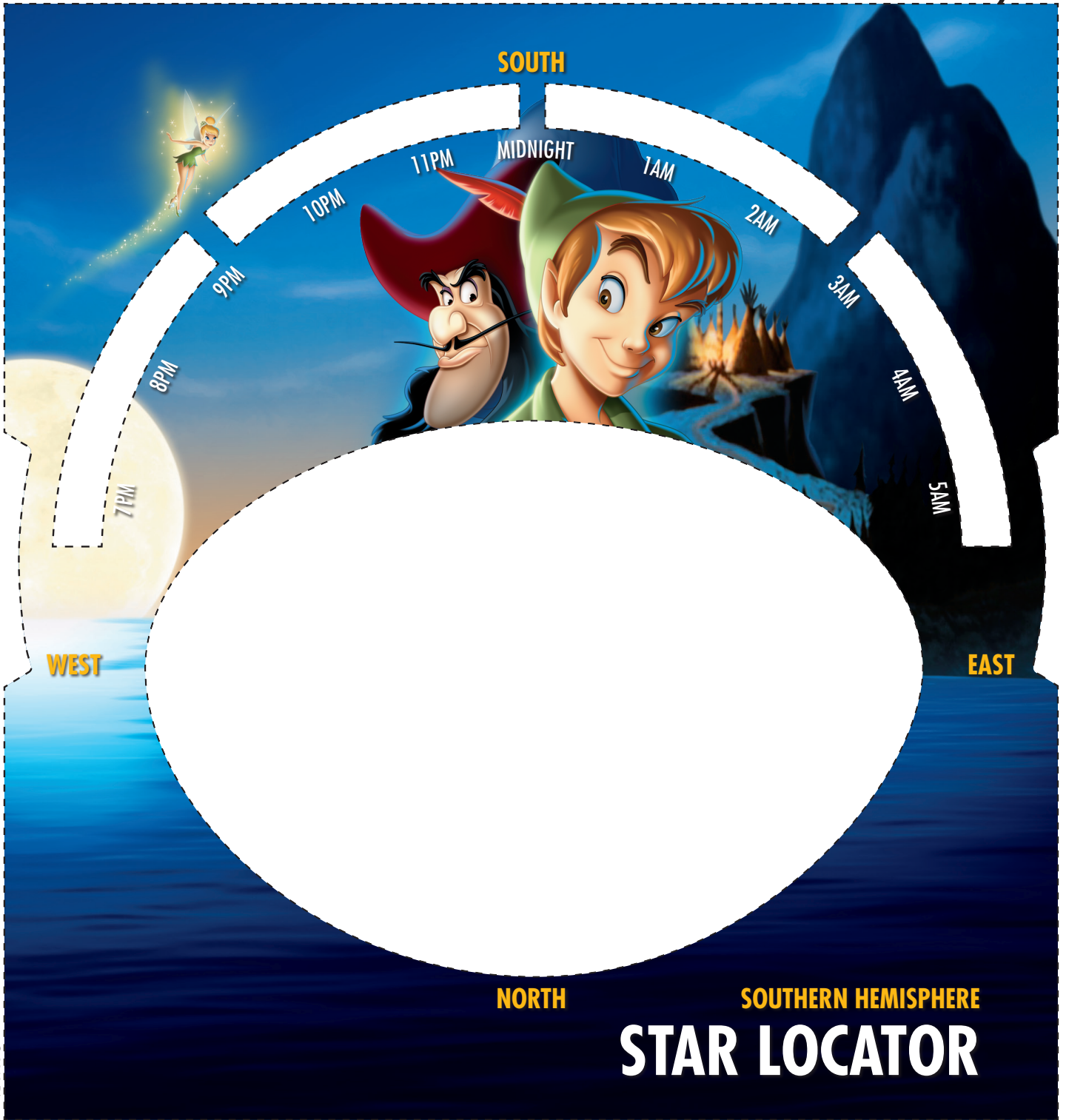

© 2018 Disney

Disney
PETER PAN
ANNIVERSARY EDITION

NOW AVAILABLE ON DIGITAL

If you live below the equator, print this page out. This is the back side of your star locator.
Have an adult help you with this craft.



STAR LOCATOR

Outer space is filled with trillions of stars and planets! For thousands of years, long before the invention of the telescope, humans observed and studied the twinkling lights that fill our night skies. Early star gazers would locate and identify stars by grouping and connecting them in shapes called constellations. Constellations are basically dot-to-dot pictures made from the stars above. These pictures were created and used by farmers, poets and astronomers to tell stories, mark the seasons and map the heavens. Now you can find these constellations yourself using your own STAR LOCATOR!

Because of Earth's rotation the locations of stars and constellations are always moving. By adjusting the time and date settings on your STAR LOCATOR, you can see a map of the constellations that are visible from where you are.

Please note: This chart reads Standard Time, please set the chart back an hour to adjust for Daylight Savings Time.

- 1) Rotate the star wheel so that the TIME lines up with the current DATE.
- 2) Use a compass or ask a grown-up to help you find NORTH.
- 3) Hold the STAR LOCATOR above your head and look up at it.
- 4) Rotate the whole STAR LOCATOR so that NORTH is pointing north and SOUTH is pointing south.
- 5) The stars will appear in the same relative positions on the STAR LOCATOR as they do in the sky.

If you'd like to see the stars and planets close up, visit the worldwide telescope online at nasa.gov and see images from all over the universe!

If you live below the equator, print this page out. This is the star wheel. Have an adult help you with this craft.

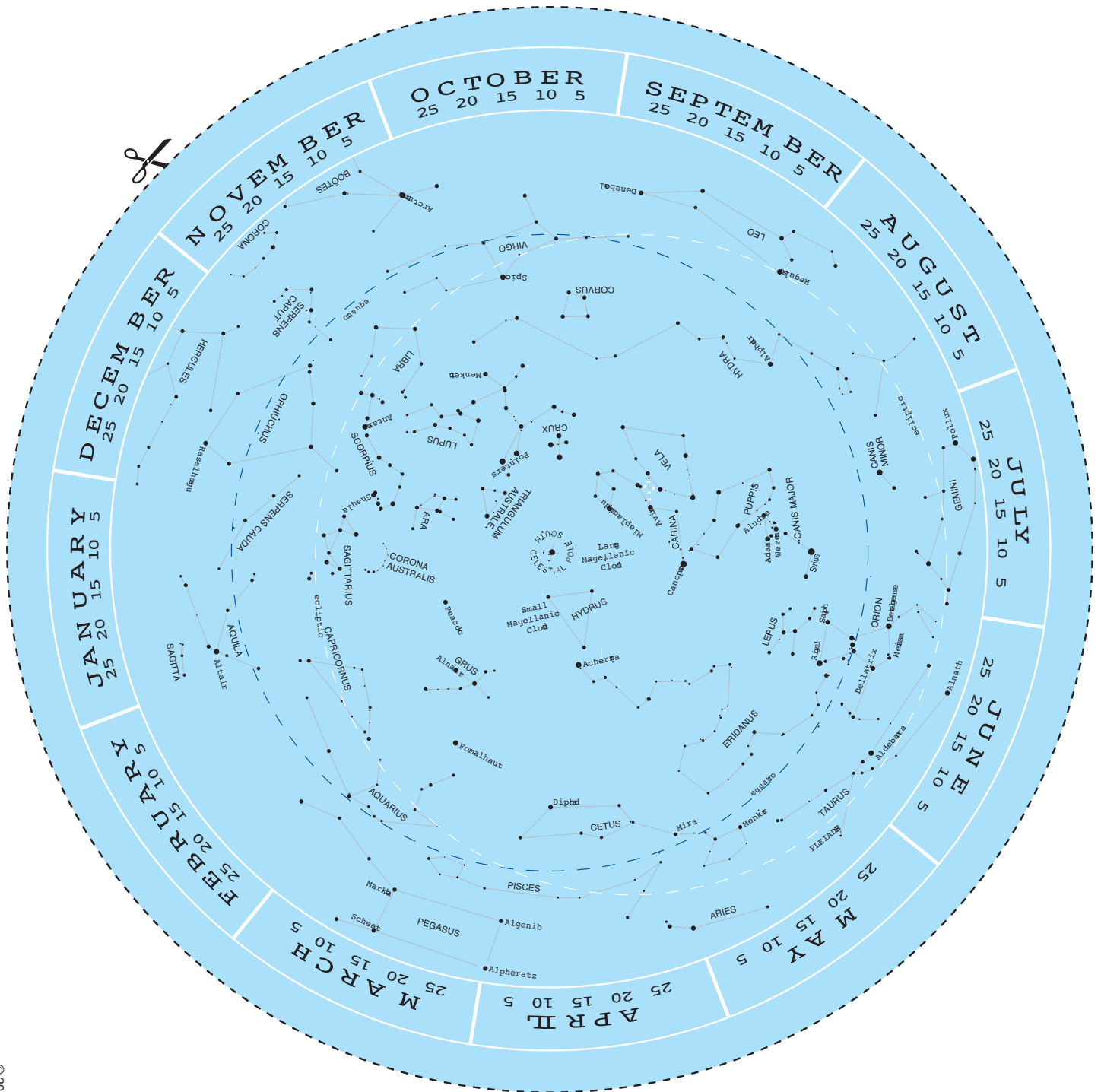

© 2018 Disney

NEVER LAND'S PIRATE PUZZLES



Every row, column and mini-grid must contain all four of these images: You do not need to guess if you use your magical logic skills!

REMEMBER!

Each column must have one of each shape.
Each row must have one of each shape.

COLOR IN BEST PALS PETER PAN AND TINKER BELL



© 2018 Disney

Disney
PETER PAN
ANNIVERSARY EDITION

NOW AVAILABLE ON DIGITAL

THE DARLING STAR GAZERS

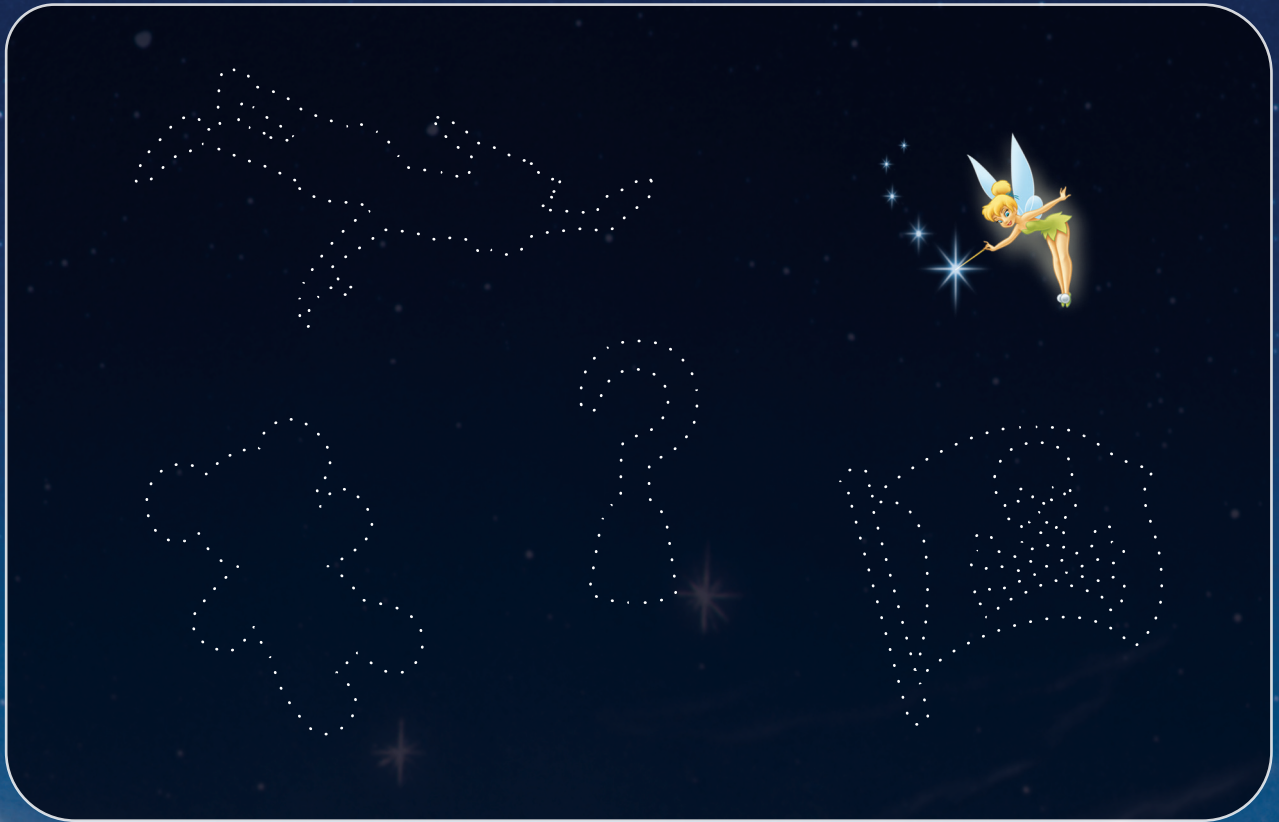

Tinker Bell sprinkled a little extra pixie dust across the night sky – connect the brightest stars together to help Wendy, John and Michael find the shapes that Tinker Bell has hidden in the stars.

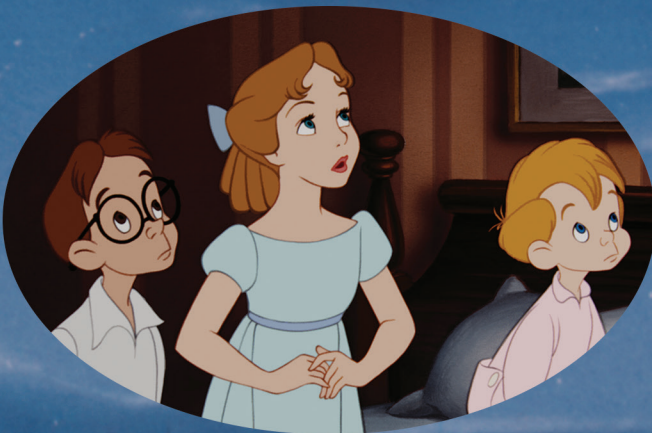

© 2018 Disney

Disney
PETER PAN
ANNIVERSARY EDITION

NOW AVAILABLE ON DIGITAL